

Car Number	Chassis Number
F16-K03	ZVW50-8011924

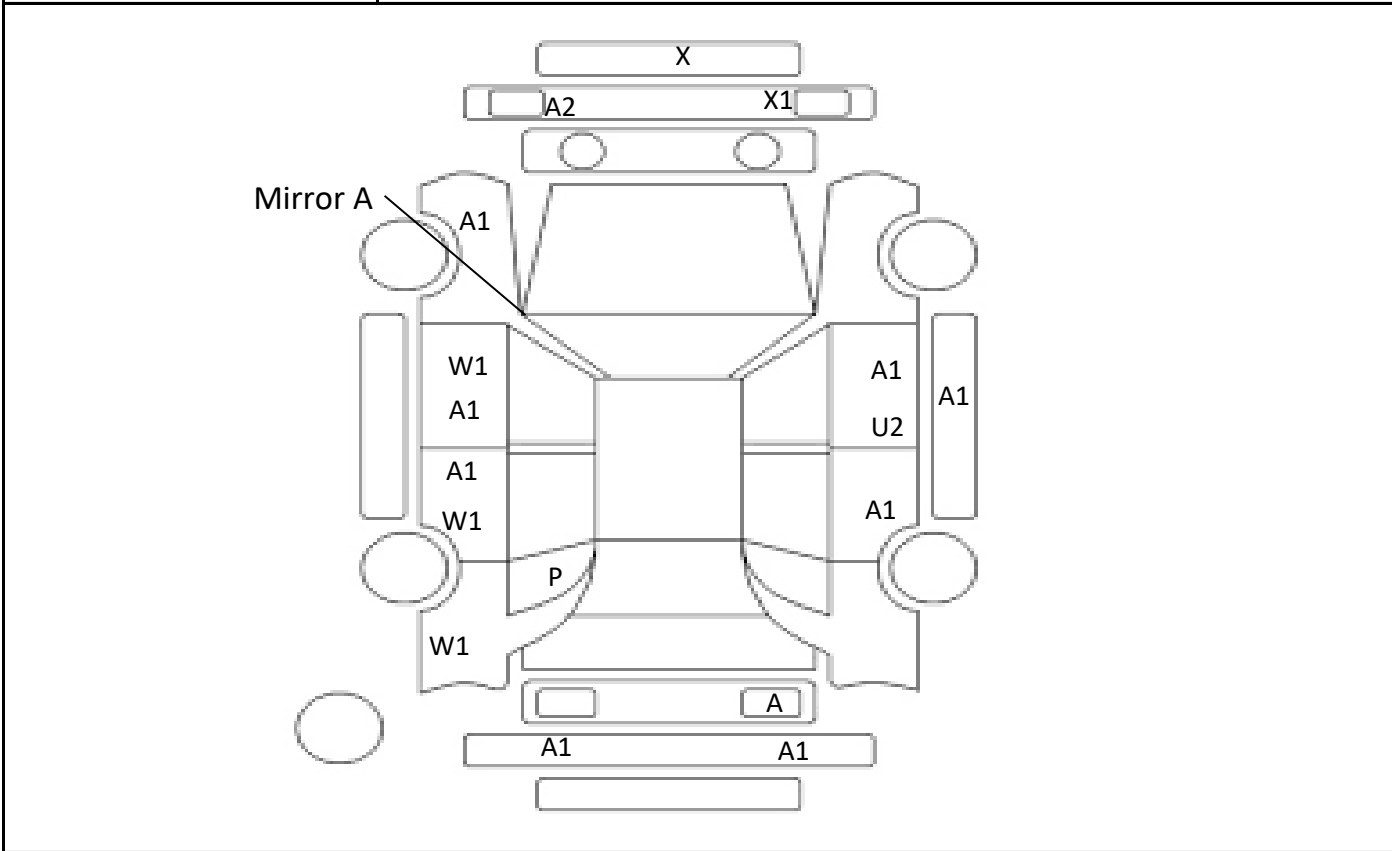

(Remark)

A(Scratch) U(Dent) S(Rust) W(Uneven paint) X(Crack) C(Corrode) P(Paint Faded)
 XX(Replacement) X(Replacement requires) G(Stone chip in the glass) Scale: 1 < 2 < 3 < 4